

Quinn



CLASSICS



Als Familienunternehmen leben wir die Werte,
 die Generationen miteinander und Familien untereinander verbinden:
 Gemeinschaft, Verantwortung füreinander sowie die Liebe zum Schmuck ist es,
 wofür wir leben und arbeiten. Natürlichkeit und Authentizität sind uns dabei
 besonders wichtig. Dies zeigt sich in der hohen Qualität der Verarbeitung ebenso
 wie im klaren und schlichten Design unseres Schmucks.
 So schaffen wir authentischen Schmuck für echte Gefühle.

*As a family-owned company we uphold values which have been
 passed down from generation to generation and which bind families together:
 A spirit of community and mutual responsibility allied with our love for jewellery constitute
 the basic principles of our everyday life and work. We set great store by adopting a natural
 approach and acting with integrity. All of this is reflected in the high quality of
 workmanship and the clarity and simplicity of our jewellery design.
 That's how we create authentic jewellery as an expression of genuine feelings.*

*** SO MESSEN SIE RICHTIG HOW TO MEASURE THE RIGHT WAY**

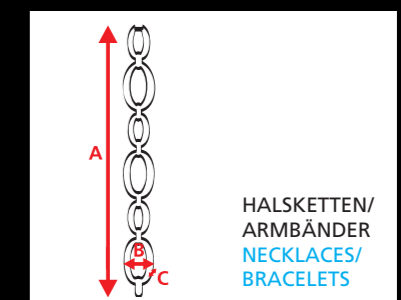
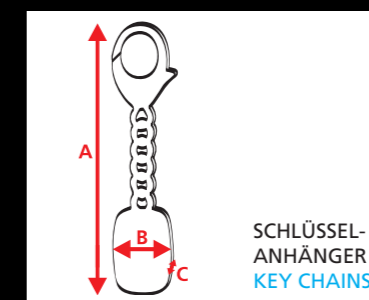
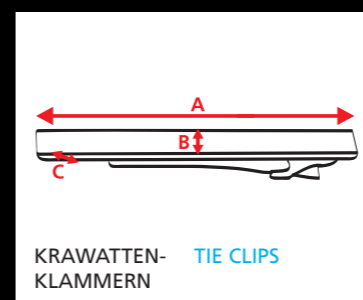
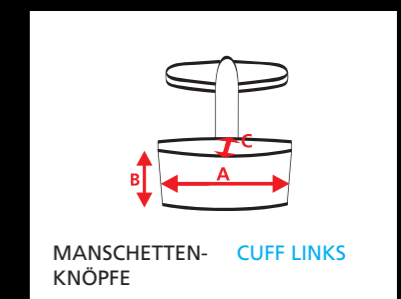
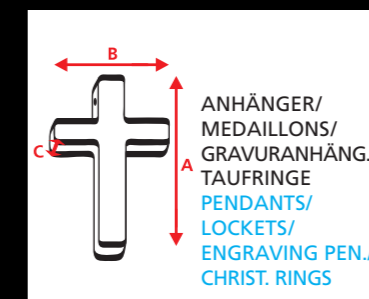
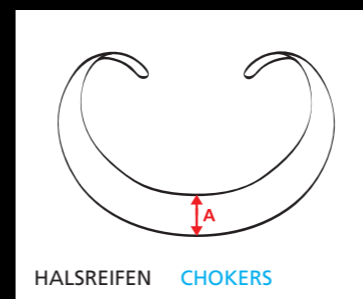
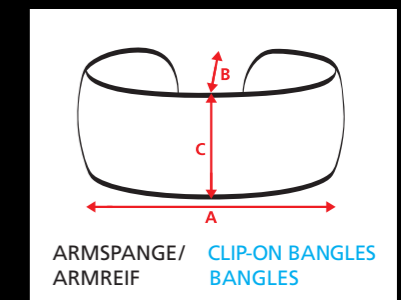
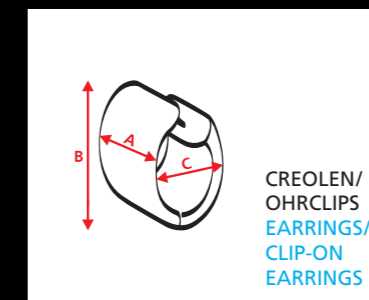
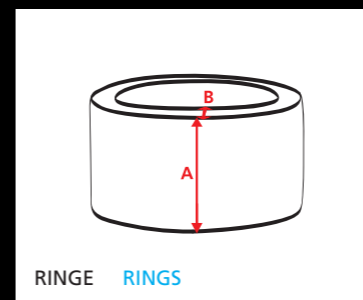

Alle Produkte sind in Originalgröße dargestellt, Abweichungen aufgrund des Aufnahmewinkels sind jedoch möglich.
 All products images are true to scale. Variations in dimension may occur due to shooting angle of the camera.



RINGE RINGS



022 7626
9,3 x 9,8 mm



022 0857
6 x 4,5 mm



022 0846
4,5 x 4,5 mm



022 0746
3,5 x 3,5 mm



022 2256
16 x 4 mm



022 2237
14 x 3,8 mm



022 2226
12 x 4,3 mm



022 4657
13,8 x 5 mm



022 2277
16 x 3 mm



022 2337
14 x 4,5 mm



022 2177
11 x 2,5 mm



022 3626
15,5 x 3,3 mm



022 0056
22 x 9 mm



022 7816
14,5 x 6 mm



022 3356
11 x 4,5 mm



022 4757
13,4 x 2,8 mm



022 5567
15 x 3,4 mm



022 5596
14 x 3,2 mm



022 5536
8,5 x 3 mm



022 0357
7 x 3,5 mm



022 5977
14 x 7,3 mm



022 5967
10,8 x 5,8 mm



022 4607
14,3 x 3,4 mm



022 3707
13,2 x 3,8 mm



022 025605
47 x 3 mm



022 5197
27 x 2 mm



022 0657
22,5 x 6,5 mm



022 6267
11 x 5 mm

CREOLEN EARRINGS



036 7780
13,5 x 20 x 17 mm



036 8310
14,5 x 18 x 14 mm



036 8610
11,5 x 17 x 14 mm



036 5940
12,3 x 19 x 16 mm



036 3665
6 x 40 x 40 mm



036 9210
6 x 36 x 36 mm



036 9200
8,2 x 31 x 31 mm



036 1820
9 x 20 x 20 mm



036 8010
4,7 x 17 x 17 mm



036 8050
6 x 16 x 16 mm



036 8000
3,5 x 14 x 14 mm



036 4840
7,5 x 22 x 22 mm



036 4750
11 x 18 x 18 mm



036 0290
10 x 16 x 16 mm



036 8040
8,6 x 15 x 15 mm



036 5340
9 x 14 x 14 mm



026 6501
20,5 x 29 mm

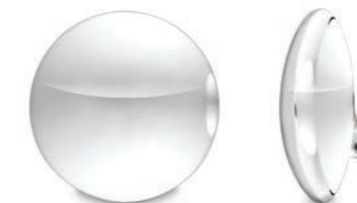

026 8341
25,3 x 25,3 mm



026 0008
21 x 24 mm



036 0620
11,2 x 17 x 17 mm



036 5120
8 x 15 x 11,4 mm



036 9400
8,6 x 16 x 13 mm



036 0610
7,8 x 13 x 13 mm



026 0050
18,5 x 18,5 mm



026 0014
16 x 21 mm



026 0006
10 x 18,7 mm



036 7620
8,5 x 28 x 28 mm



036 5960
9 x 21 x 21 mm



036 7740
6,8 x 20 x 20 mm



036 5190
13 x 19 x 12 mm



026 0870
11,5 x 18,5 mm



026 8090
9,4 x 18,4 mm

OHRCLIPS CLIP-ON EARRINGS



ARMSPANGEN CLIP-ON BANGLES



029 5790
64 x 50 x 41 mm



029 0009
64 x 53 x 40 mm



029 0008
64 x 50 x 35 mm



029 0006
64 x 46 x 27 mm



029 3700
65 x 54 x 24 mm



029 4650
60 x 47 x 23 mm



029 0005
64 x 48 x 20 mm



029 0025
61 x 50 x 20 mm



029 0004
64 x 50 x 14 mm

ARMREIFEN BANGLES



029 3910
64 x 64 x 15 mm



029 3960
58 x 53 x 15 mm



029 3930
64 x 64 x 12 mm



029 3350
60 x 53 x 15,2 mm



029 3940
59 x 50 x 12 mm



029 3860
59 x 52 x 8 mm



029 8760
60 x 54 x 25 mm



029 8660
60 x 57 x 20 mm



029 8460
59 x 52 x 14 mm



029 8360
59 x 52 x 10 mm



029 5960
58 x 53 x 10 mm



029 5380
59 x 52 x 10 mm



029 8160
60 x 53 x 7 mm



029 5140
59 x 55 x 6 mm



029 7990
59 x 52 x 28 mm



029 7690
58 x 53 x 18 mm



029 0430
64 x 64 x 24 mm



029 0420
64 x 64 x 20 mm



029 0410
64 x 64 x 16 mm



029 0400
64 x 64 x 12 mm



029 5190
66 x 52 x 32 mm



029 4750
62 x 53 x 21 mm

ARMBÄNDER BRACELETS



028 1400
210 x 12 x 3 mm



028 0440
200 x 14 x 3 mm



028 0632
210 x 17 x 5 mm



028 0450
200 x 20 x 5 mm



028 2851
210 x 13 x 4 mm



028 2861
210 x 20 x 6 mm



028 2873
220 x 22 x 6 mm



028 4750
200 x 8 x 2 mm



028 4833
220 x 12 x 2 mm



028 2605
250 x 19 x 4 mm



028 4600
220 x 18 x 4 mm



028 0682
210 x 20 x 3 mm



028 1661
200 x 12 x 2 mm



028 1711
200 x 12 x 3 mm



028 2481
195 x 10 x 3 mm



028 0131
200 x 11 x 11 mm



028 5570
220 x 12 x 4 mm



028 1420
180 x 21 x 4 mm



HALSKETTEN NECKLACES



027 0914
450 x 12 x 5 mm



027 1404
450 x 12 x 3 mm



027 1444
450 x 14 x 3 mm



027 0634
450 x 17 x 5 mm



027 0454
450 x 20 x 5 mm



027 4754
450 x 8 x 2,5 mm



027 4834
460 x 12 x 2 mm



027 2605
450 x 19 x 4 mm



027 4604
460 x 18 x 3,5 mm



027 0684
450 x 20 x 3 mm



027 1664
470 x 12 x 2 mm



027 1714
460 x 12 x 3 mm



027 2484
450 x 10 x 2 mm



027 0134
470 x 11 x 3 mm



027 5574
460 x 12 x 4 mm



027 1424
450 x 16 x 3 mm

HALSREIFEN CHOKERS





MEDAILLONS I GRAVURANHÄNGER

LOCKETS I ENGRAVING PENDANTS



024 8551
54 x 40 x 12 mm



024 8421
46 x 35 x 10 mm



024 8431
47 x 34 x 10 mm



024 8211
35 x 27 x 9 mm



024 8111
30 x 24 x 5 mm



024 8131
30 x 23 x 8 mm



024 8021
26 x 21 x 5 mm



024 8052
26 x 21 x 5 mm



024 3141
25 x 25 x 8 mm



024 3211
23 x 23 x 5 mm



024 8011
22 x 18 x 6 mm



024 8001
16 x 14 x 5 mm



024 7970
20 x 12 x 3 mm



024 7370
17 x 17 x 3 mm



024 7311
14 x 14 x 2 mm



024 7524
12,5 x 9 x 3 mm



HERZANHÄNGER HEART PENDANTS



024 6351
39 x 45 x 15 mm



024 0610
27 x 27 x 15 mm



024 6441
18 x 21 x 10 mm



024 1710
14 x 15 x 5 mm



024 6421
13 x 15 x 8 mm



024 6210
11 x 12 x 4 mm



024 6021
13 x 15 x 3 mm



024 6110
9 x 10 x 3 mm



024 6031
10 x 12 x 2 mm



024 6039
10 x 12 x 2 mm



024 0052
8 x 10 x 1,4 mm



024 9052
8 x 10 x 1,4 mm



024 6100
17 x 11 x 5 mm



024 6109
17 x 11 x 5 mm



024 3909
9 x 10 x 4 mm

ANHÄNGER PENDANTS



024 6260
55 x 41 x 3 mm



024 3680
39 x 39 x 4 mm



024 7620
34 x 34 x 9 mm



024 5960
26 x 26 x 7 mm



KREUZANHÄNGER CROSS PENDANTS



024 2451
29 x 20 x 2,5 mm



024 2340
30 x 20 x 3 mm



024 2570
28 x 21 x 4 mm



024 2821
22 x 15 x 2,5 mm



024 2970
29,5 x 18 x 4 mm



024 3030
24 x 14 x 4 mm



024 2910
19 x 12 x 4 mm



024 2040
15 x 14 x 3 mm



024 2321
19 x 14 x 2 mm



024 2323
19 x 14 x 2 mm



024 5100
17 x 13 x 3 mm



024 2601
18 x 13 x 1 mm



024 2161
20 x 13 x 2 mm



024 2191
20 x 13 x 2 mm



024 2700
18 x 14 x 3,5 mm



024 2709
18 x 14 x 3,5 mm



024 2050
13 x 10 x 3 mm



024 2059
13 x 10 x 3 mm



024 2010
11 x 10 x 3 mm



024 2019
11 x 10 x 3 mm



024 2000
9 x 8 x 2,5 mm



024 2009
9 x 8 x 2,5 mm

OMEGARUNDKETTEN OMEGA NECKLACES

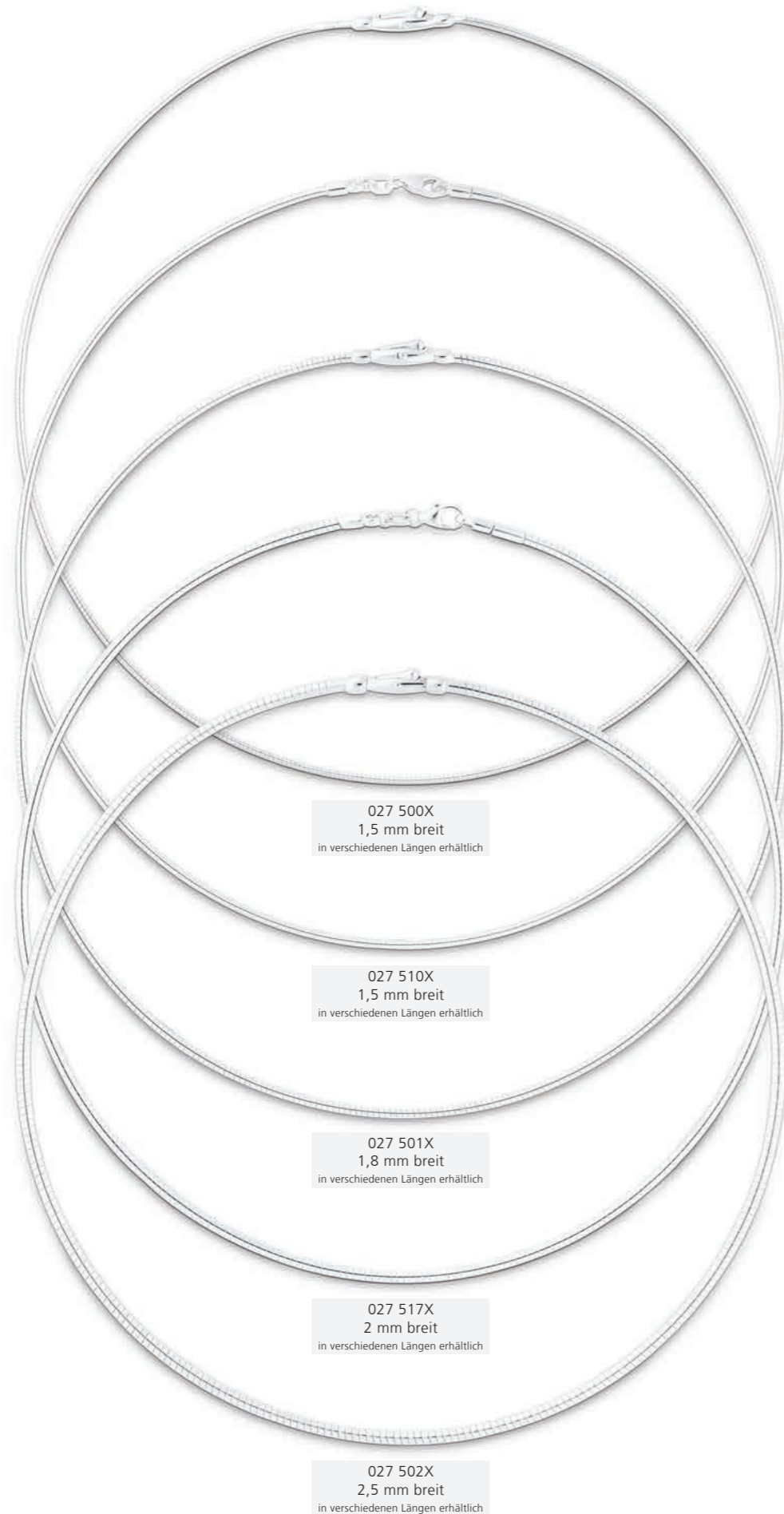

027 500X
1,5 mm breit
in verschiedenen Längen erhältlich

027 510X
1,5 mm breit
in verschiedenen Längen erhältlich

027 501X
1,8 mm breit
in verschiedenen Längen erhältlich

027 517X
2 mm breit
in verschiedenen Längen erhältlich

027 502X
2,5 mm breit
in verschiedenen Längen erhältlich

COLLIERKETTEN NECKLACES



027 044X
2,1 mm breit
in verschiedenen Längen erhältlich

027 043X
1,7 mm breit
in verschiedenen Längen erhältlich

027 049X
1,4 mm breit
in verschiedenen Längen erhältlich

027 048X
2 mm breit
in verschiedenen Längen erhältlich

027 010X
1,6 mm breit
in verschiedenen Längen erhältlich

027 022X
1,8 mm breit
in verschiedenen Längen erhältlich

027 047X
2,5 mm breit
in verschiedenen Längen erhältlich

027 174X
4 mm breit
in verschiedenen Längen erhältlich

027 181X
4,8 mm breit
in verschiedenen Längen erhältlich



MANSCHETTENKNÖPFE CUFF LINKS



001 7629 2
20 x 16 x 4 mm



001 2589 2
19 x 13 x 4 mm



001 1179 2
14 x 14 x 3 mm



001 7629 5
20 x 16 x 4 mm

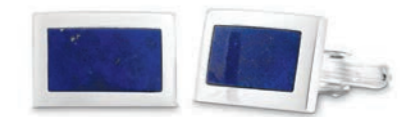

001 2589 5
19 x 13 x 4 mm



001 1179 5
14 x 14 x 3 mm



001 7629 17
20 x 16 x 4 mm



001 2589 17
19 x 13 x 4 mm



001 1179 17
14 x 14 x 3 mm



001 7629 19
20 x 16 x 4 mm



001 2589 19
19 x 13 x 4 mm



001 1179 19
14 x 14 x 3 mm



001 4329 2
19 x 19 x 3 mm



001 4329 17
19 x 19 x 3 mm



001 4059 2
14 x 14 x 4 mm



001 5289 55
17 x 12 x 4 mm



001 0170
21 x 15 x 4 mm



001 5301
19 x 14 x 5 mm



001 5201
17 x 12 x 5 mm



001 0500 1
25 x 17 x 4 mm



001 0380
20 x 12 x 3 mm



001 0270
20 x 12 x 3 mm



001 2730 05
21 x 12 x 3 mm



001 8501
21 x 13 x 5 mm



001 0120 05
20 x 11 x 3 mm



001 0600 1
20 x 20 x 4 mm



001 1401
15 x 15 x 3 mm



001 4401
15 x 15 x 8 mm



001 0800
18 x 18 x 3 mm



001 1420 05
15 x 15 x 3 mm



001 2202
25 x 8 x 5 mm

KRAWATTENKLAMMERN TIE CLIPS



010 8400 05
68 x 7 x 4 mm



010 3130
66 x 5 x 5 mm



010 1610
65 x 5 x 2 mm



010 0120 05
64 x 6 x 2 mm



010 0270
65 x 7 x 2 mm

TAUFRINGE CHRISTENING RINGS



024 0020
12 x 12 x 5 mm



024 0031
11 x 11 x 3,5 mm



024 0002
11 x 11 x 4 mm



024 0001
10 x 10 x 5 mm



024 0092
11 x 11 x 4 mm



024 00924
11 x 11 x 4 mm



024 00925
11 x 11 x 4 mm



024 00926
11 x 11 x 4 mm



024 0091
10 x 10 x 4 mm



024 00914
10 x 10 x 4 mm



024 00915
10 x 10 x 4 mm



024 00916
10 x 10 x 4 mm



030 70714
107 x 20 x 6 mm



030 85604
100 x 25 x 3 mm



030 0742
100 x 29 x 5 mm



030 70134
93 x 29 x 9 mm

SCHLÜSSELANHÄNGER KEY CHAINS



030 2422
110 x 23 x 5 mm



030 2471
104 x 25 x 5 mm



030 81651
105 x 17 x 4 mm



030 1000
114 x 27 x 4 mm



030 1040
100 x 20 x 19 mm



030 1060
90 x 38 x 17 mm



030 7500
66 x 21 x 5 mm



030 6440
55 x 31 x 5 mm

VEREDELTE OBERFLÄCHEN

PRECIOUS METAL-PLATED FINISHES



Alle „Classics“-Silberartikel sind auch mit einer Oberflächenveredelung aus mindestens 18 Karat Gelb- oder Roségold erhältlich. Dabei handelt es sich um eine hochwertige Goldplattierung mit einer Schichtstärke von 3 bis 5 Mikron - jeweils abhängig von der Artikelgruppe. Zudem sind Beschichtungen mit Schwarz-Ruthenium oder dem weißen Rhodium möglich. Letztere werden mit einer technisch maximal möglichen Schichtstärke von 0,2 bis 0,3 Mikron durchgeführt. Dies garantiert eine sowohl hohe Farbechtheit als auch Beständigkeit der veredelten Oberfläche über einen längeren Zeitraum. Der exakte Preis einer gewünschten Veredelung hängt von der spezifischen Fläche des betreffenden Artikels sowie der Schichtstärke der gewählten Veredelung ab und kann Ihnen von unserem Verkaufsteam stets „auf Knopfdruck“ unter der +49 (0)7171 6000-0 genannt werden.

On request we can offer our silver „Classics“ with a high quality plating of at least 18 carat yellow or rose gold with a layer thickness of 3 to 5 microns. This thickness depends on the article in question. We also offer black ruthenium or white rhodium coatings produced to the maximum technically possible thickness of 0.2 to 0.3 microns. This guarantees high-level colour authenticity as well as long-term durability of our finishes. The exact price of the desired finishing depends both on the specific surface area of the particular article and on the layer thickness of the chosen coating. All price information is available on demand from our sales team by phone at +49 (0)7171 6000-0.

MATTE & GEKRATZTE OBERFLÄCHEN

MATTE & SCRATCH FINISHES



Viele unserer „Classics“ sind nicht nur in polierter, sondern auch - wie hier abgebildet - in matter sowie gekratzter Oberfläche erhältlich. Bitte erfragen Sie den Preiszuschlag für die verschiedenen Oberflächenvarianten unter der +49 (0)7171 6000-0.

Many of our „Classics“ are available not only with a polished finish, but also - as shown here above - with a matte as well as a scrape finish. Please address your feasibility and price inquiries regarding finishing options to our sales team by phone at +49 (0)7171 6000-0.

GEHÄMMERTE OBERFLÄCHE HAMMERED FINISH



022 4706 09

022 2256 09



022 0256 09



027 0127

027 0025

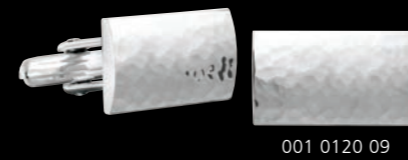

001 0120 09



010 0120 09

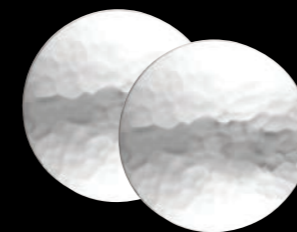

026 8341 09

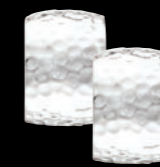

036 7820

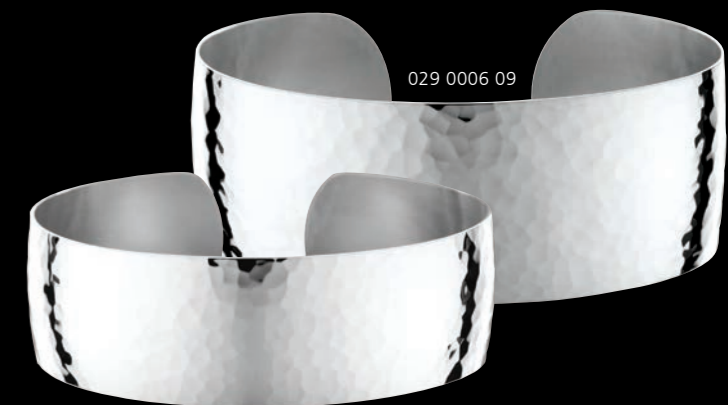

029 0006 09

029 0015



SETS „NATIVE“ & „BRAIDED“



SET NATIVE

- 022 5427. Ring / ring. 13 x 3,5 mm
- 036 5420. Creole / earring. 10 x 14,5 x 16 mm
- 024 5420. Anhänger / pendant. 51 x 24 x 1,5 mm
- 029 5420. Armreif / bangle. 66 x 57 x 26 mm



SET BRAIDED

- 022 3707. Ring / ring. 15 x 5 mm
- 029 3700. Armreif / bangle. 65 x 54 x 24 mm



SETS „SWING_CLASSIC“ & „SERENITY“

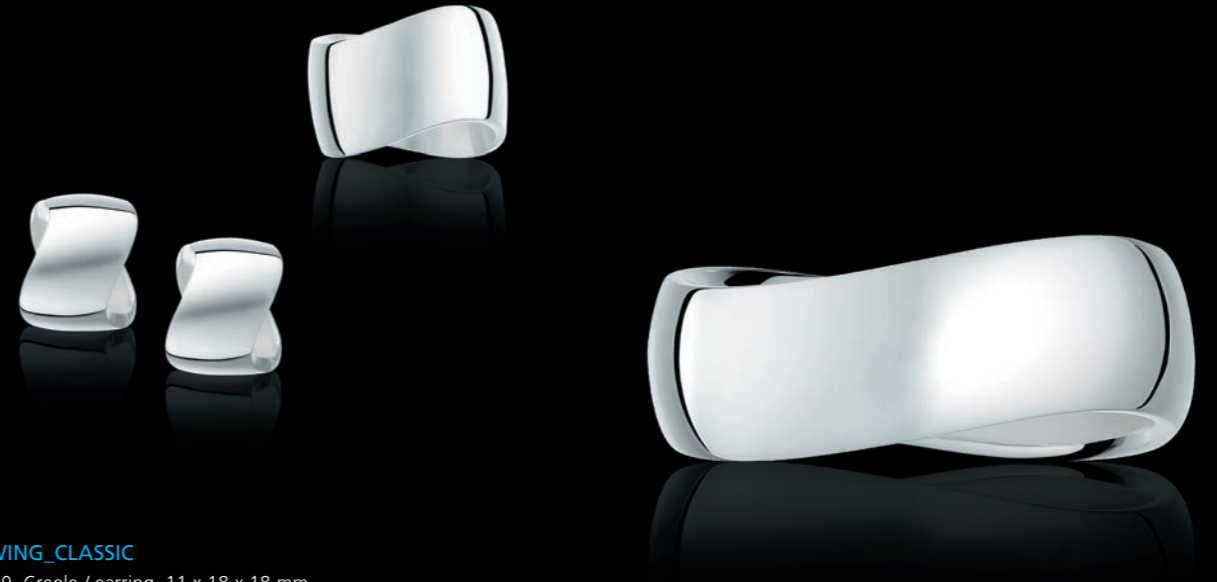

SET SWING_CLASSIC

036 4750. Creole / earring. 11 x 18 x 18 mm
022 4757. Ring / ring. 13,4 x 2,8 mm
029 4750. Armreif / bangle. 62 x 53 x 21 mm



SET SERENITY

036 0620. Creole / earring. 11,2 x 17 x 17 mm
022 2277. Ring links / ring on the left. 16 x 3 mm
022 2177. Ring rechts / ring on the right. 11 x 2,5 mm
029 7990. Armreif links / bangle on the left. 59 x 52 x 28 mm
029 7690. Armreif rechts / bangle on the right. 58 x 53 x 18 mm



Quinn

QUINN Scheurle GmbH
Gutenbergstr. 23 @ DE-73525 Schwäbisch Gmünd
Tel. +49 (0)7171 6000-0 @ Fax +49 (0)7171 6000-11
www.quinn.de